

✧

✧

✧

✧

✧

✧

◇

◇

◇

◇

◇

◇

◇

◇



◇

◇

◇

◇

◇

◇

◇

◇

◇

◇

◇

◇

◇



◇

◇

◇

◇

◇

◇

◇

◇

◇

◇

◇

◇

◇

◇



◇

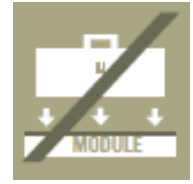

◇

◇

◇

◇

◇

◇

◇

◇

◇

◇

◇

◇

◇

◇

◇

◇

◇

◇

- ◇
- ◇
- ◇
- ◇
- ◇

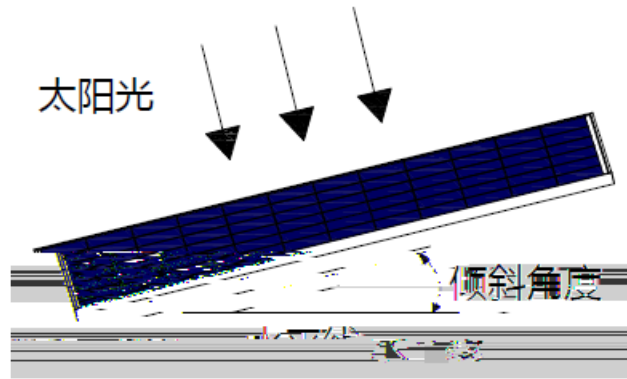
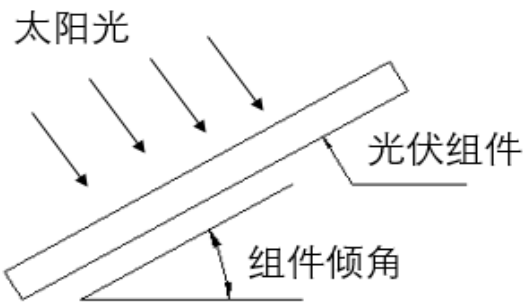

- ◇
- ◇
- ◇
- ◇
- ◇
- ◇
- ◇
- ◇
- ◇
- ◇



◇

◇

◇

◇

◇

◇

◇

◇

◇

◇

◇

◇

◇

◇

.

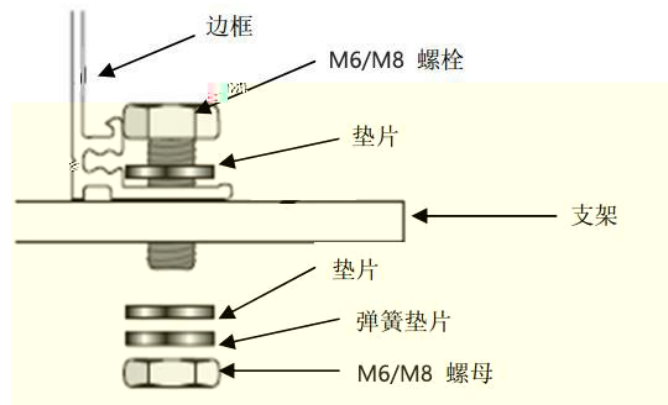

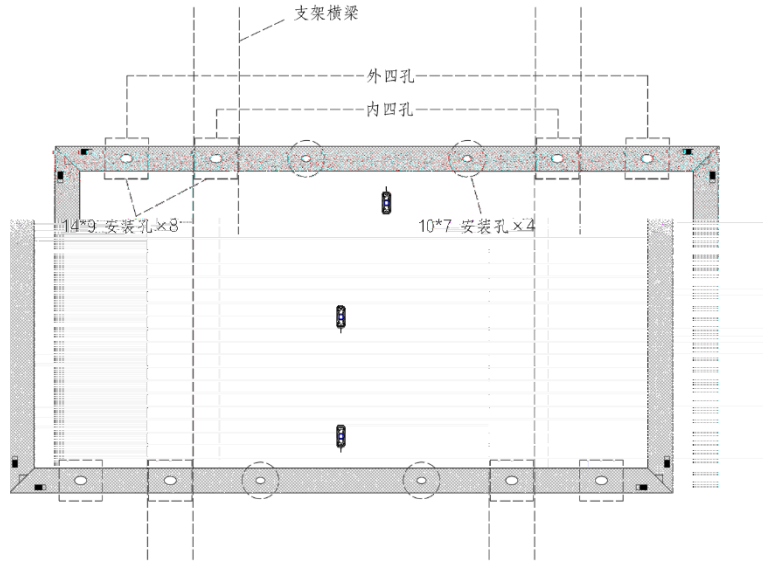

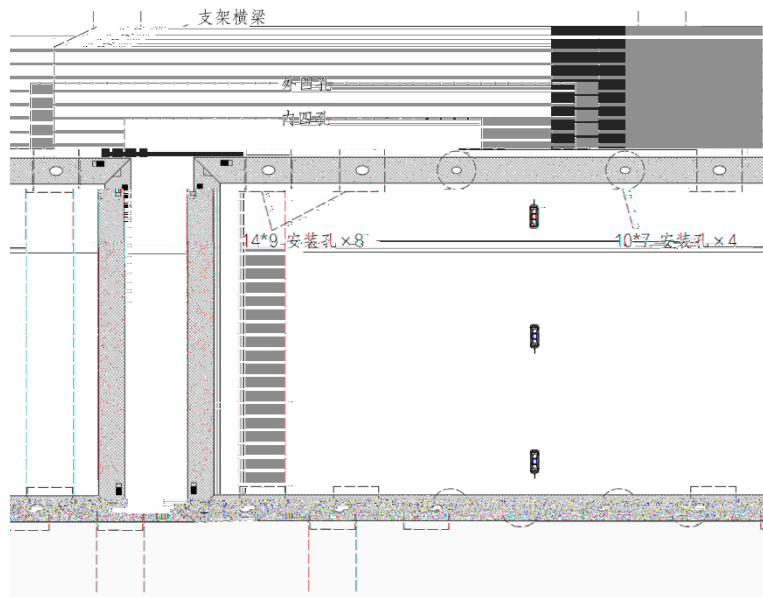

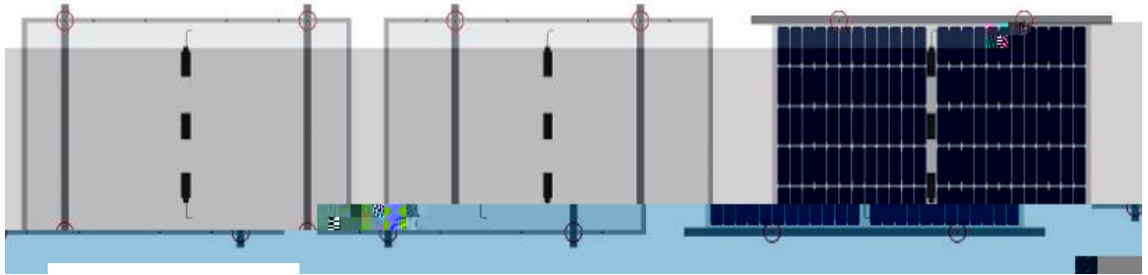

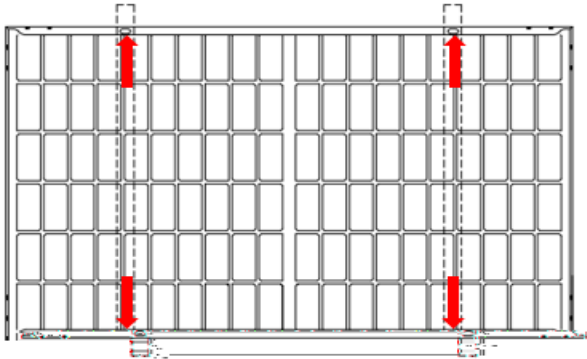

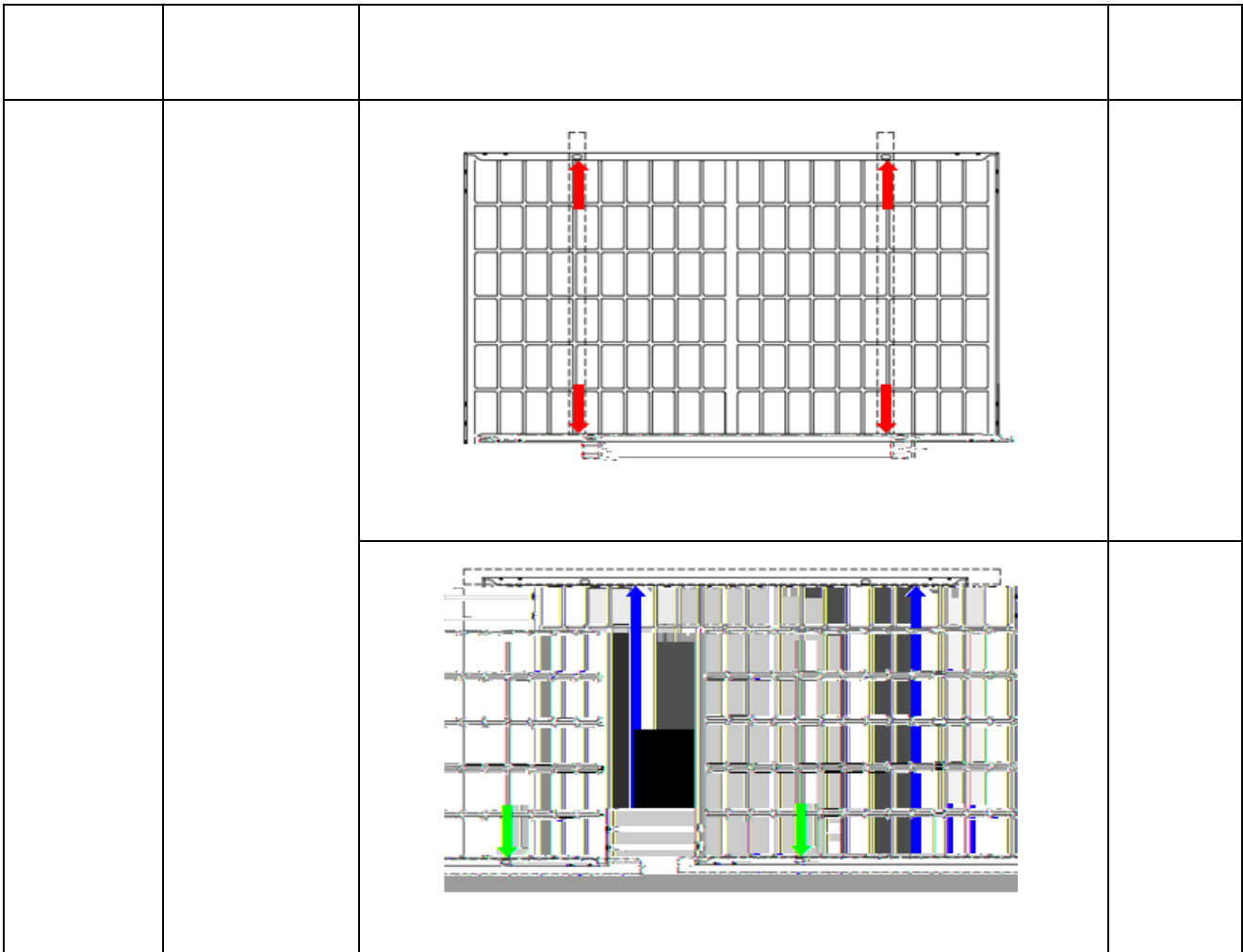
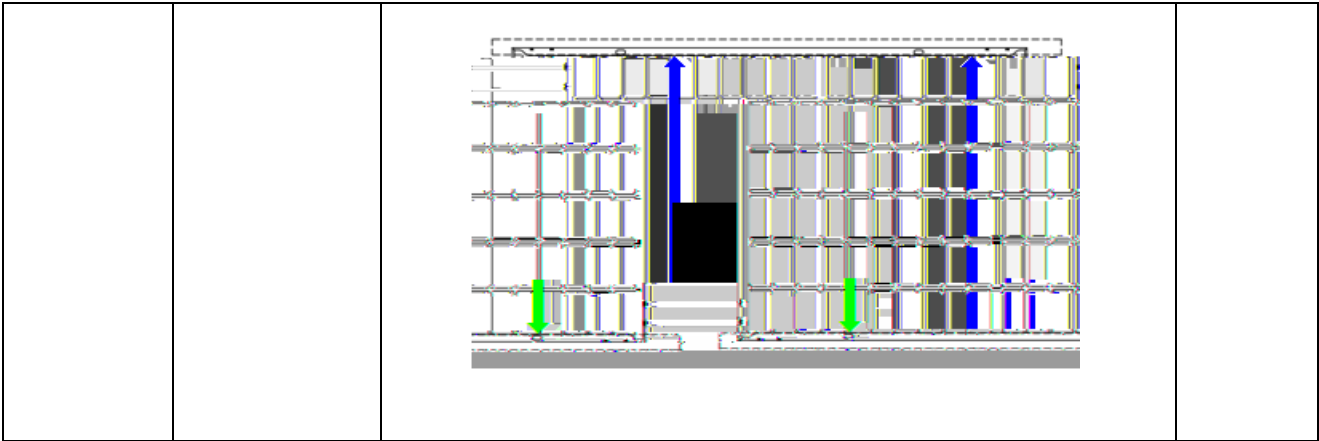

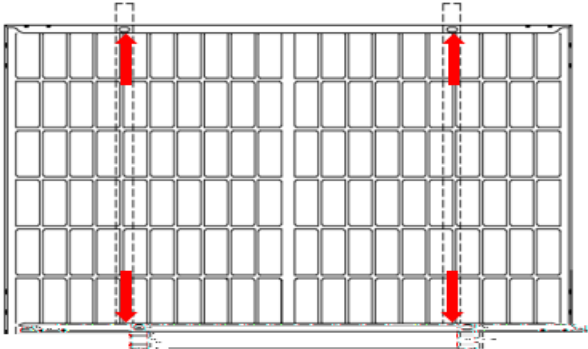
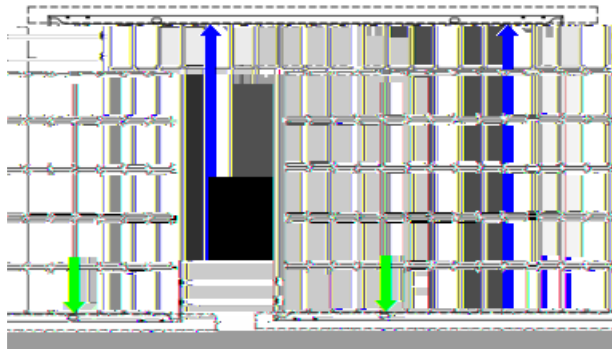

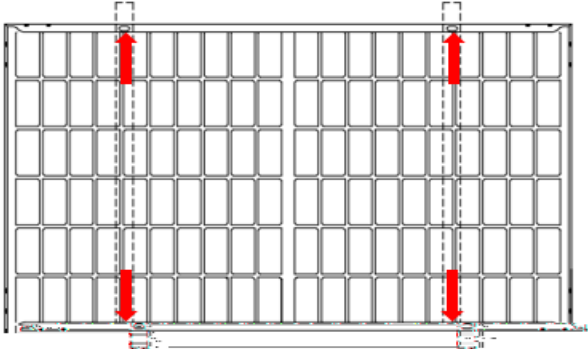

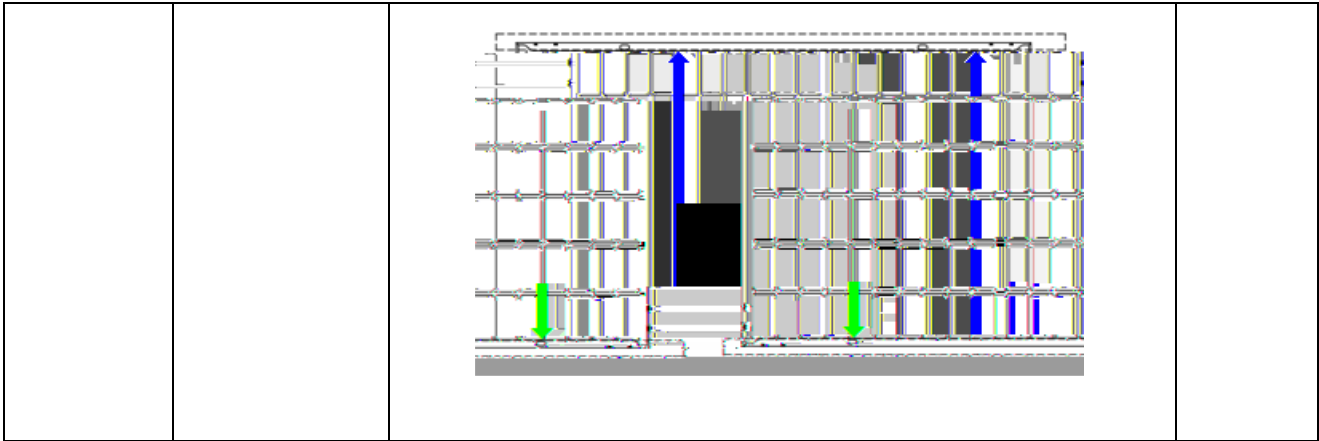
- ◇
- ◇
- ◇
- ◇
- ◇
- ◇
- ◇
- ◇
- ◇

4 3 4 5

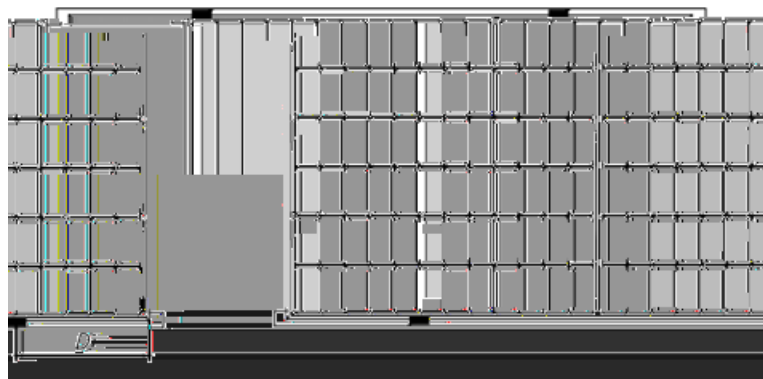

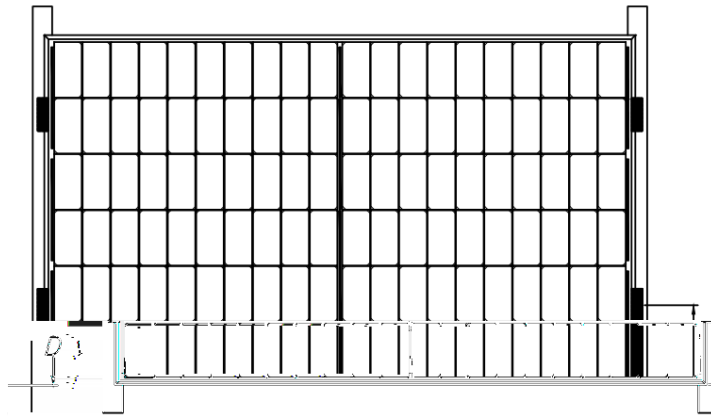
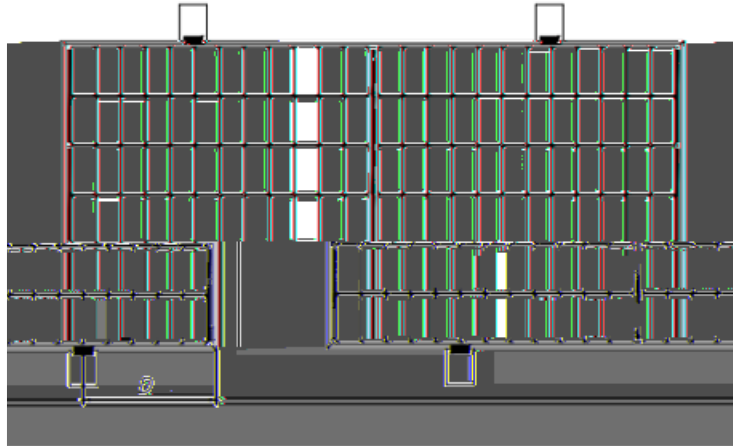

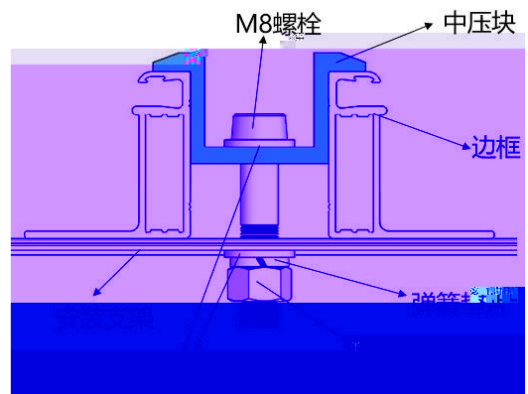
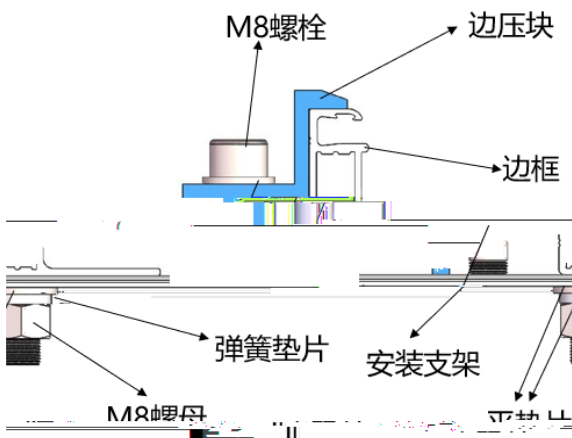
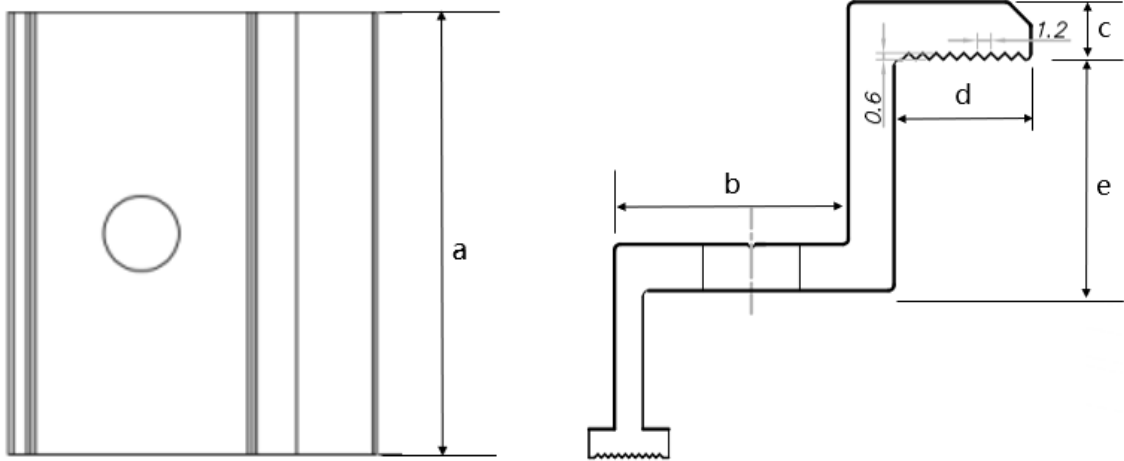

- ◇
- ◇
- ◇
- ◇
- ◇
- ◇

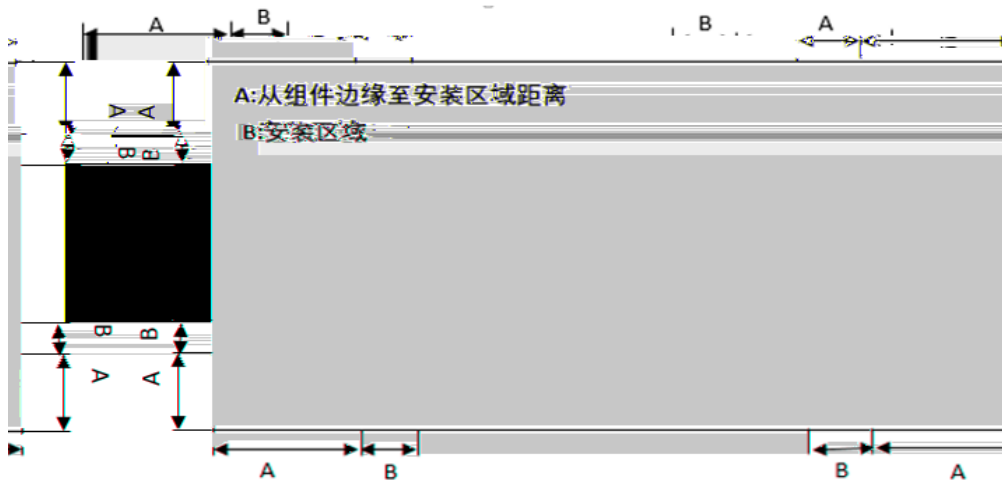

- ◇
- ◇
- ◇

◇

◇

◇

◇

◇

◇

◇

◇

◇

◇

◇

◇

◇

◇

◇

◇

◇

◇

◇

◇

◇

◇

◇

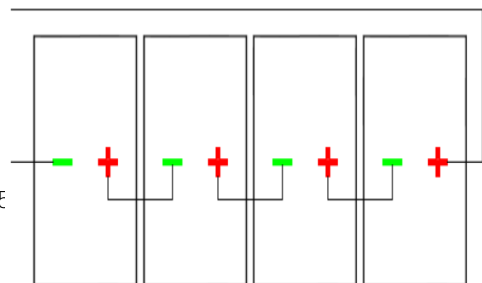
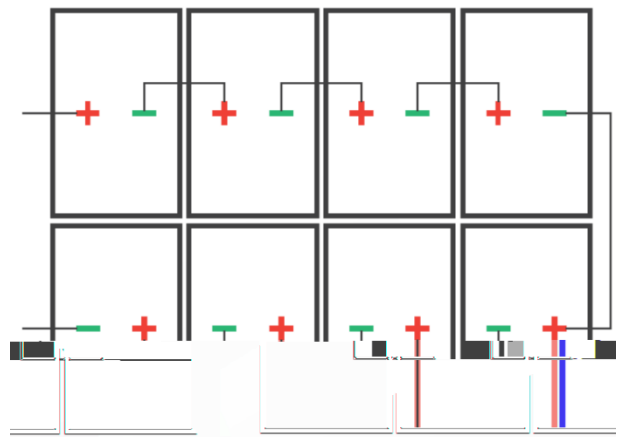

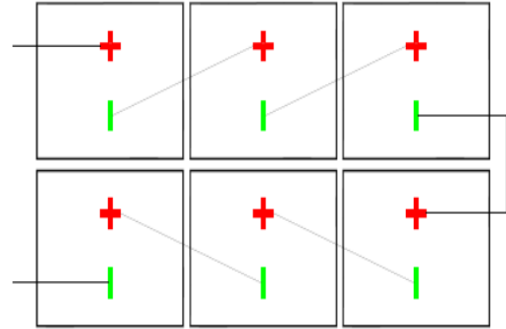

◇

◇

◇

◇

◇

◇

◇

◇

1.

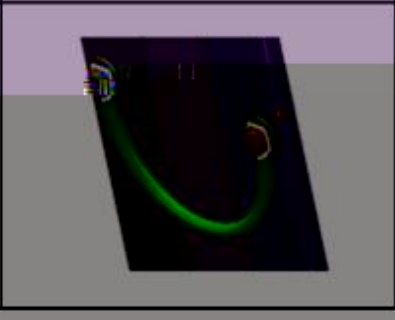
	示图	连接方式
		<p>将星形垫圈、平垫圈和接地线依次放置，使用螺钉穿过接地孔，再将其拧紧来固定相邻组件。</p>

2.

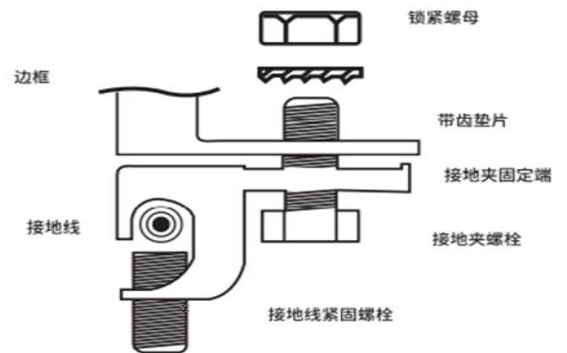

3.

✧

◇

◇



◇

◇

◇

◇

◇

◇

◇

◇

◇

◇

◇

◇

◇

◇

226001

17